

# EVOLVE<sup>2</sup> 65



## User manual

© 2020 GN Audio A/S. All rights reserved. Jabra® is a trademark of GN Audio A/S. The Bluetooth® word mark and logos are registered trademarks owned by the Bluetooth SIG, Inc. and any use of such marks by GN Audio A/S is under license.

---

Made in China  
MODEL: HSC110W



---

**Declaration of Conformity** can be found on  
[www.jabra.com/doc](http://www.jabra.com/doc)

1. Welcome.....	5
2. Jabra Evolve2 65 overview.....	6
2.1 Included accessories	
2.2 Optional accessories	
3. How to wear.....	8
3.1 Wearing styles	
3.2 Adjusting the headset	
3.3 Fold flat for storage	
4. How to charge.....	11
4.1 Charge using the charging stand (optional accessory)	
4.2 Charge using USB charging cable	
4.3 Sleep mode	
5. What the LEDs mean.....	15
6. How to connect.....	16
6.1 Connect to computer	
6.2 Pair with a smartphone	
7. How to use.....	18
7.1 Power on/off	
7.2 Calls & music	
7.3 Busylight(s)	
7.4 Mute/unmute using the microphone boom-arm	
7.5 Answer call using the microphone boom-arm	

- 7.6 Voice Assistant
- 7.7 Multiuse
- 7.8 Multiple call handling
- 7.9 Voice guidance
- 7.10 Sidetone
- 7.11 How to reset
- 8. Software and firmware ..... 28
  - 8.1 Jabra Sound+
  - 8.2 Jabra Direct
  - 8.3 Update firmware
- 9. Support ..... 30
  - 9.1 FAQ
  - 9.2 How to care for your headset

# 1. Welcome

Thank you for using the Jabra Evolve2 65. We hope you will enjoy it!

## **Jabra Evolve2 65 features**

- Comfortable noise-isolating design
- 3-microphone call technology
- Up to 37 hours wireless battery life
- 40mm speakers for exceptional music
- Up to 30m/100ft wireless range, with significantly enhanced coverage and fewer dropouts
- Works with all leading UC platforms, Microsoft Teams-certified variants available

## 2. Jabra Evolve2 65 overview

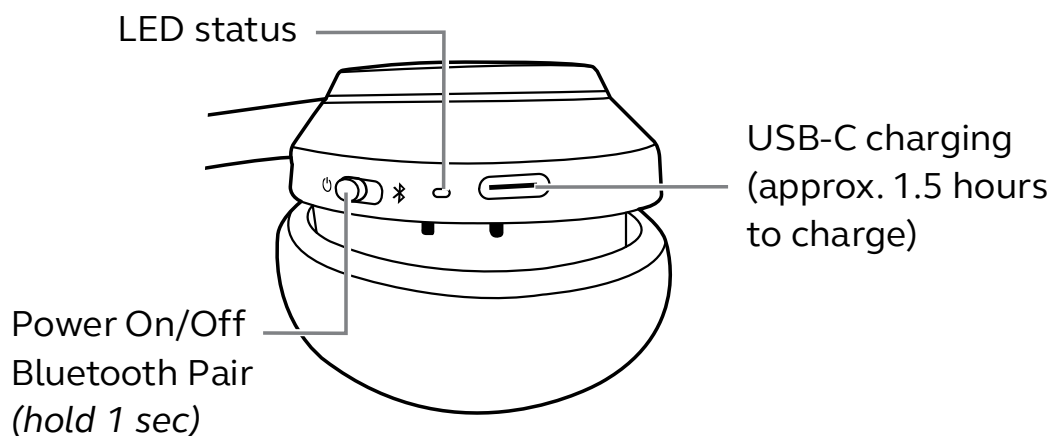
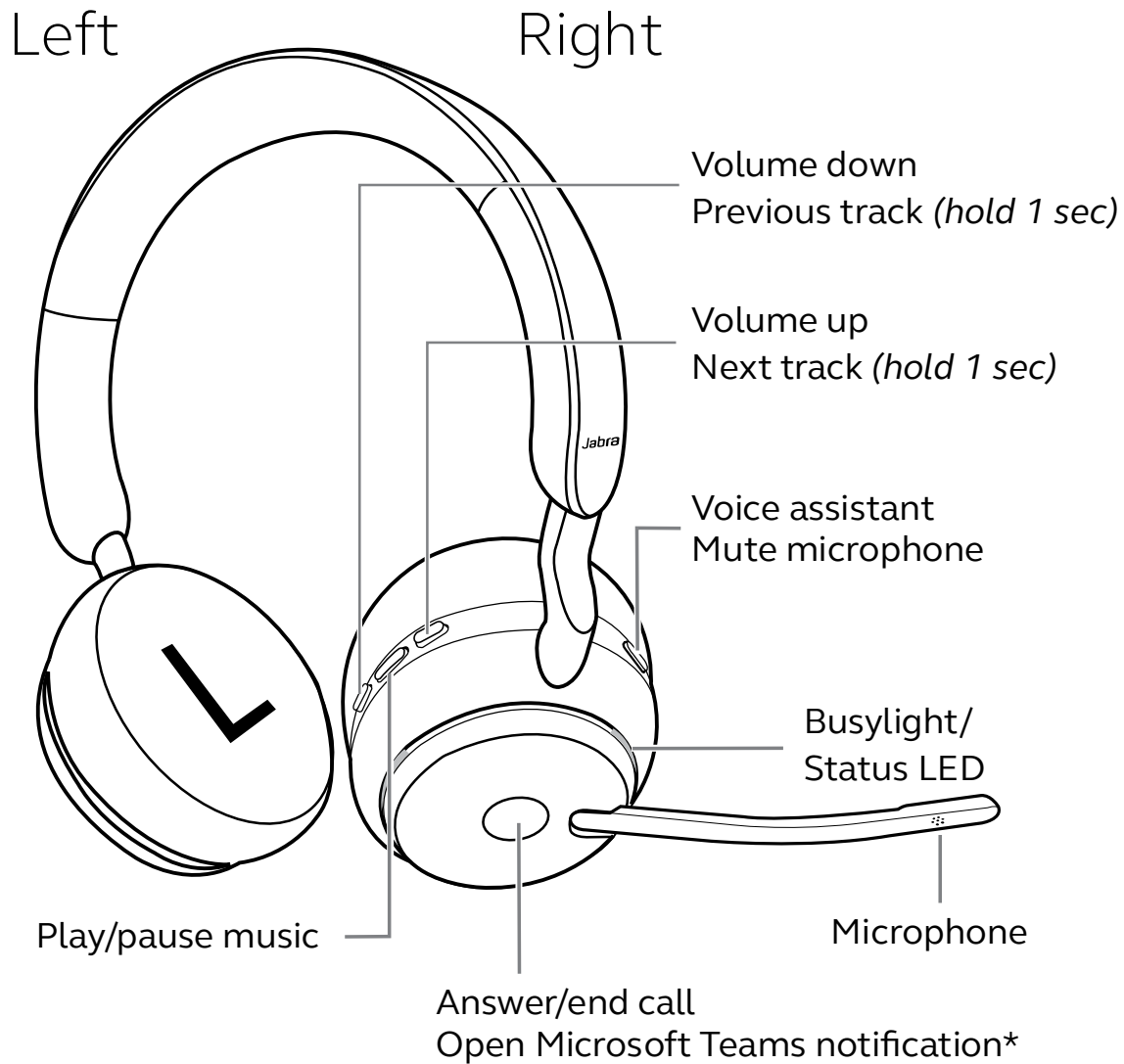

\*Requires Microsoft Teams headset variant

## 2.1 Included accessories

---

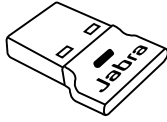

Jabra Link 380 USB-A  
Bluetooth adapter

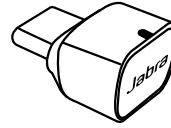

Jabra Link 380 USB-C  
Bluetooth adapter

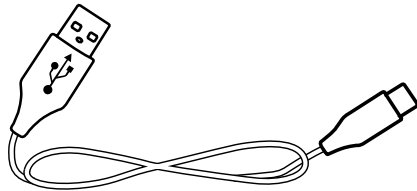

USB-A to USB-C  
charging cable

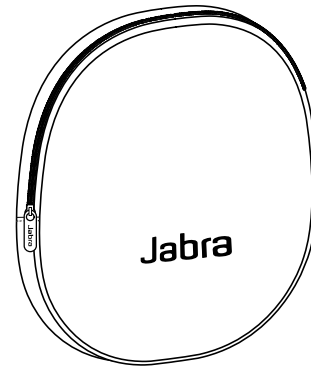

Carry case

## 2.2 Optional accessories

---

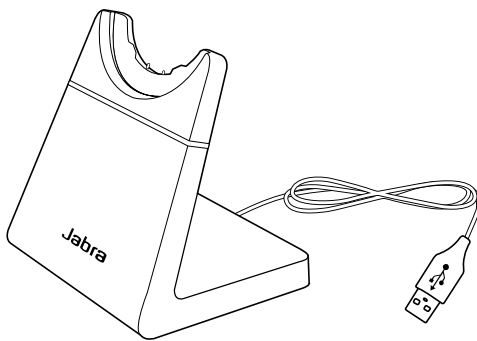

Charging Stand

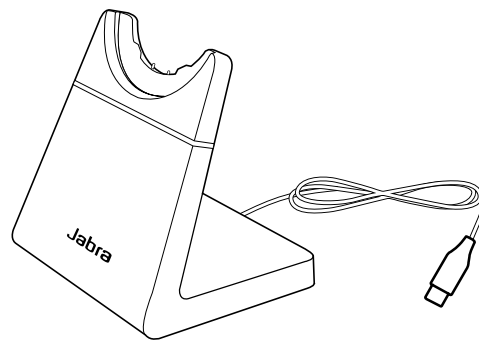

Charging Stand

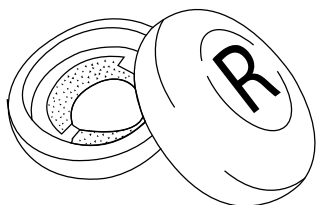

Ear cushions

# 3. How to wear

## 3.1 Wearing styles

---

### Mono variant

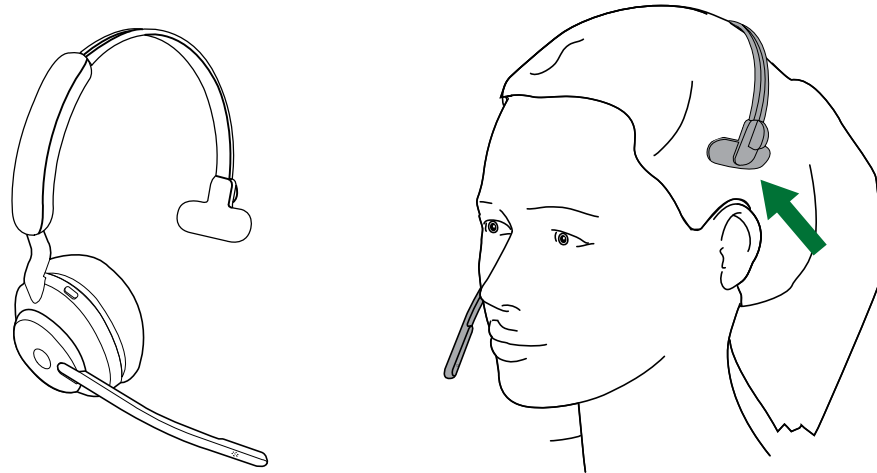

### Stereo variant

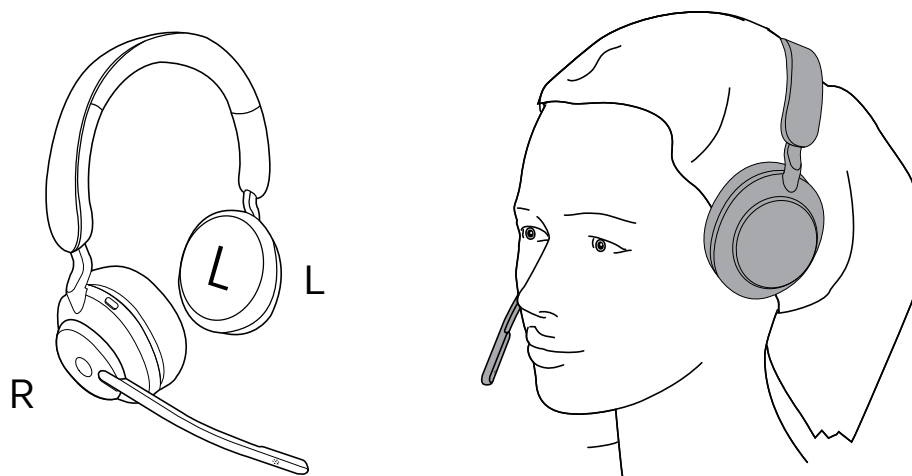



## 3.2 Adjusting the headset

---

Adjust the headband so that the headset fits your head comfortably.

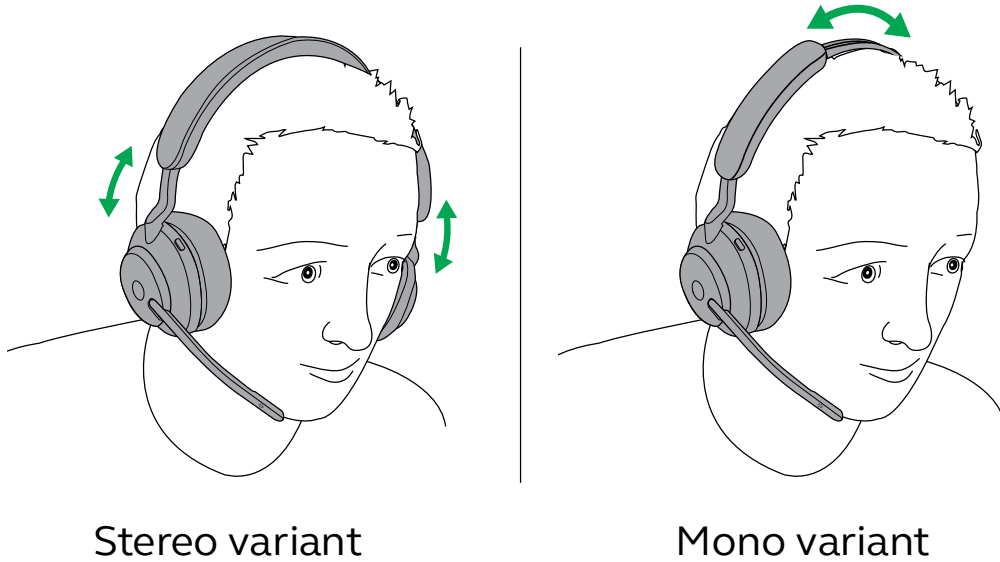

When using the microphone, it should be positioned close to your mouth.

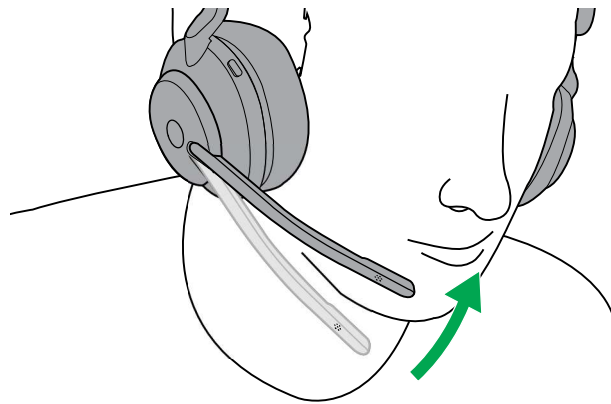

### 3.3 Fold flat for storage

---

The earcups can be folded flat for easy storage.

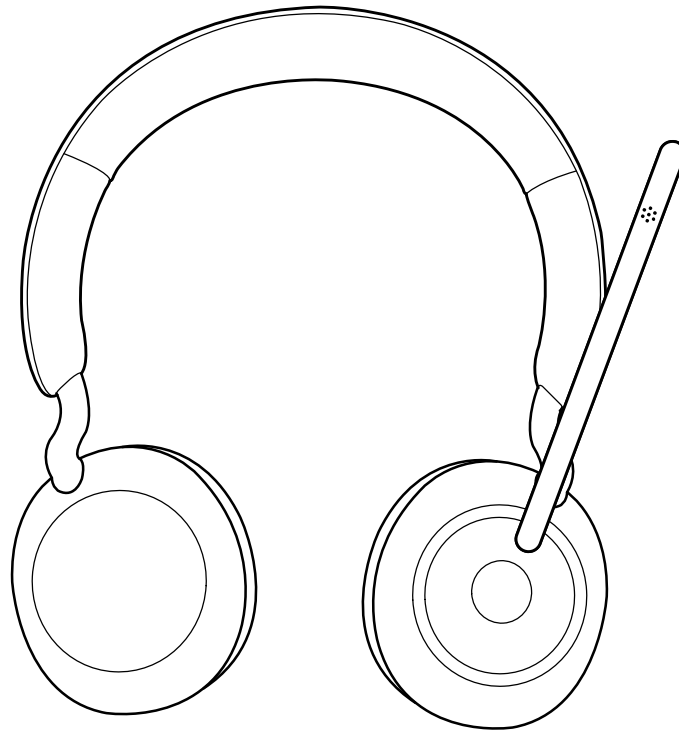

## 4. How to charge

The headset can be charged using the optional charging stand, or via a USB charging cable plugged directly into the headset.

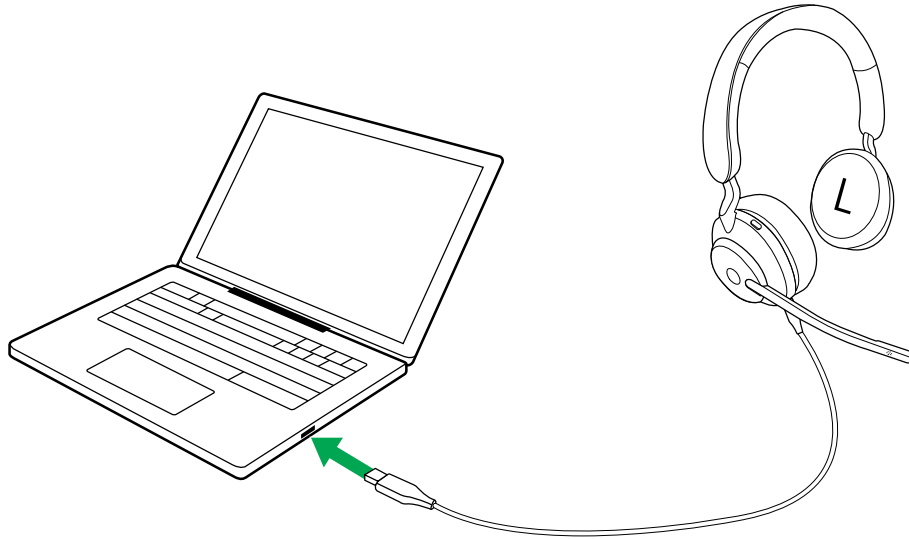

It takes approx. 1 hour and 30 minutes to fully charge. When fully charged, the battery life is up to 37 hours. If out of battery, charging the headset for 15 minutes will give up to 8 hours of battery life.

## 4.1 Charge using the charging stand (optional accessory)

---

Connect the charging stand to a powered USB port on your computer using the supplied USB charging cable, and then dock the headset in the charging stand. Alternatively, the charging stand can be plugged into any powered USB power supply.

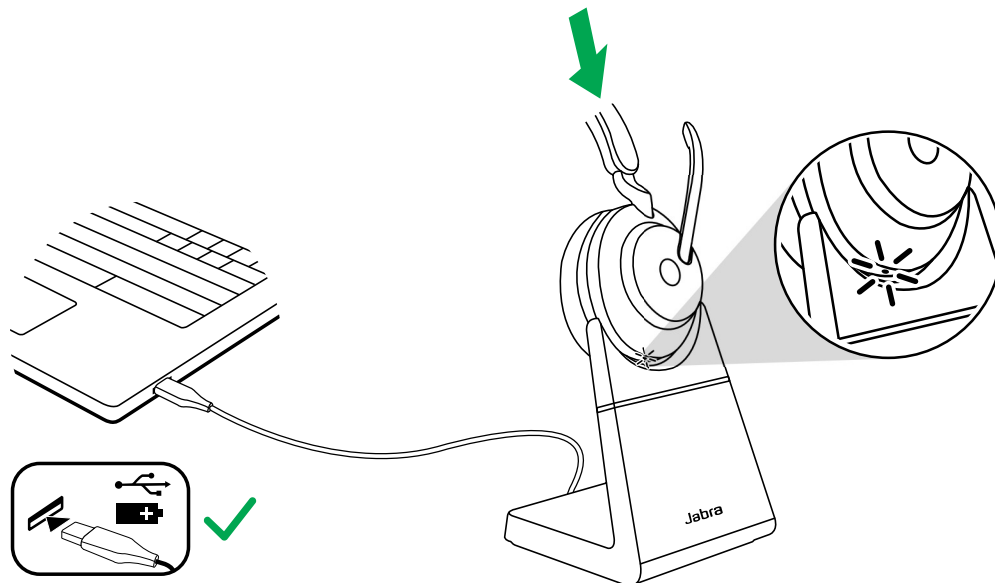

Powered USB port

The battery LED on the headset will flash white briefly to indicate the headset has been correctly docked with the charging stand.

The battery LED will then briefly flash green, yellow or red to indicate the current battery charging status. When the LED turns solid green, the headset is fully charged.

## 4.2 Charge using USB charging cable

---

Plug the USB charging cable into the USB-C charging port on the right earcup and any available USB port on your computer. It is recommended to charge the headset using the supplied Jabra charging cable, however it is possible to use a compatible charger.

Right earcup

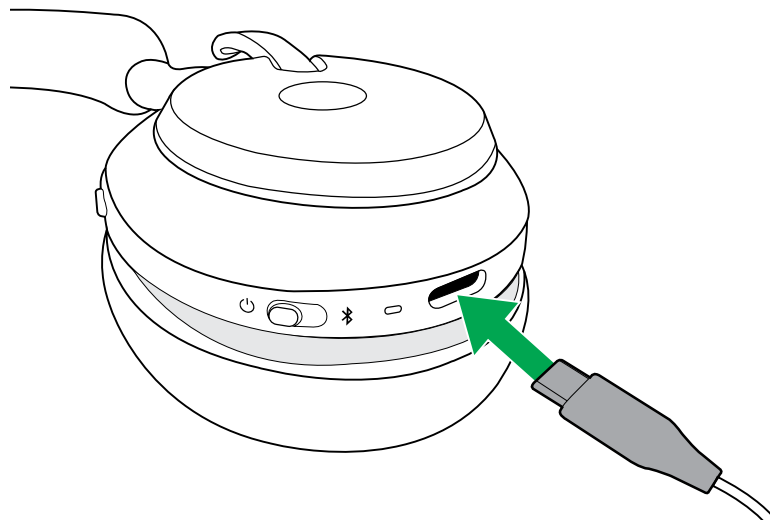

## 4.3 Sleep mode

---

When the headset is powered on, but not playing music or in a call, they will automatically enter sleep mode after 8 hours to conserve battery. To exit sleep mode, simply press any button.



The length of time before the headset enter sleep mode can be adjusted using the Jabra Sound+ app on your smartphone or Jabra Direct on your computer.

After 24 hours of sleep mode, the headset will power down completely. To power the headset on, slide the On/Off switch to Off and then On.

# 5. What the LEDs mean

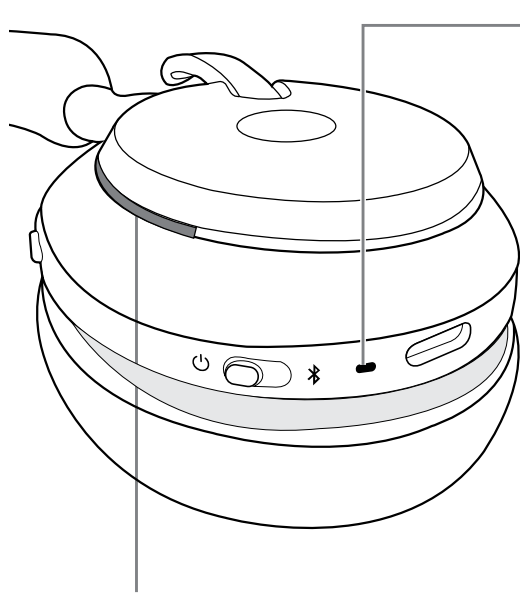

LED

- Power on  
Battery full
- Battery medium
- Battery low
- ⚡ Battery critically low
- ⚡ Pairing mode
- ⚡ Resetting/Firmware updating

BUSYLIGHT/STATUS LED

- Busylight
- Active call
- ⚡ Incoming call
- ⚡ (slow flash) Headset is trying to connect to Microsoft Teams. Will time out after 10 seconds\*
- ⚡ (fast flash) Microsoft Teams notification\*



LED

- Mute
- Plugged into computer and signed into Microsoft Teams\*
- ⚡ (slow flash) Headset is trying to connect to Microsoft Teams. Will time out after 10 seconds\*
- ⚡ (fast flash) Microsoft Teams notification\*
- Bluetooth connection
- Incoming call/Active call
- Streaming music/media

\*requires Microsoft Teams headset variant

# 6. How to connect

## 6.1 Connect to computer

---

Plug the supplied Jabra Link 380 into a USB port on your computer. The Jabra Evolve2 65 and the Jabra Link 380 are pre-paired and ready for use out of the box. The Bluetooth range is up to 30 meters or 100 feet.

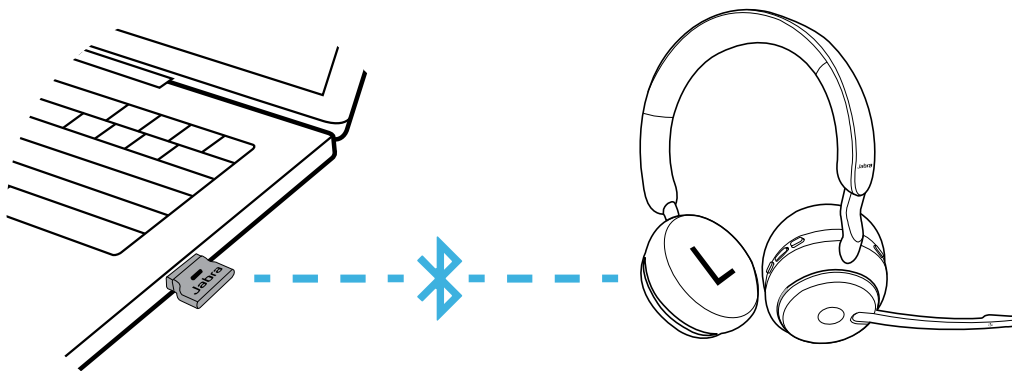

To hear music in the headset you may need to select the Jabra Link 380 as the playback device in your operating system's audio settings.

To manually pair the Jabra Evolve2 65 with the Jabra Link 380, download and use Jabra Direct.



## 6.2 Pair with a smartphone

---

1. Slide the **On/Off** switch to the **Bluetooth** position and hold it there until the LED flashes blue and you hear an announcement in the headset.

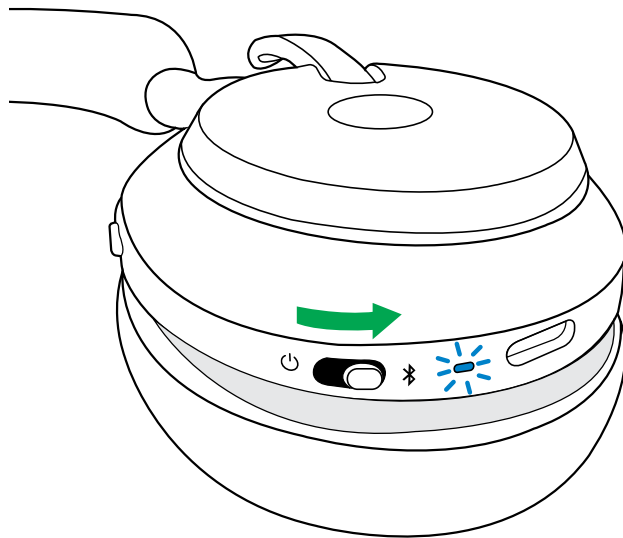

2. Go to the Bluetooth menu on your smartphone and select the Jabra Evolve2 65 from the list of available devices.

# 7. How to use

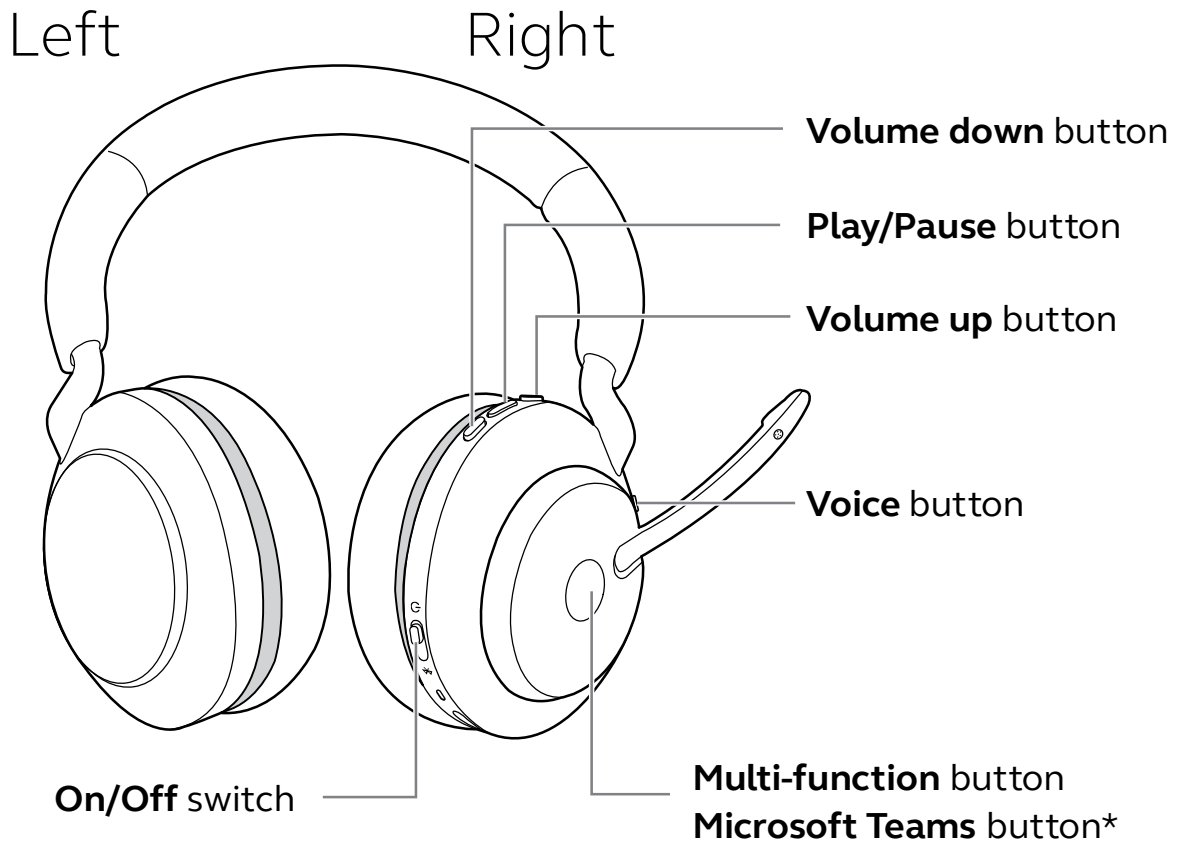

\*Requires Microsoft Teams headset variant

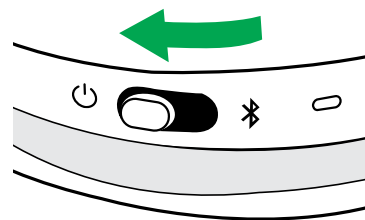
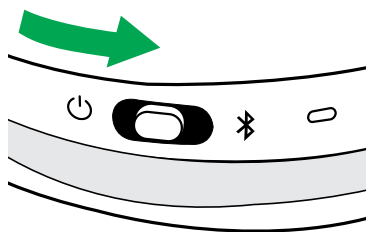

## 7.1 Power on/off

Slide the **On/Off** switch to the **On** or **Off** position to power the headset on or off.

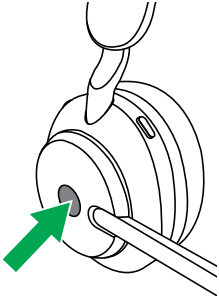

## 7.2 Calls & music

---

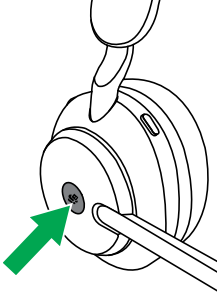
Right	Calls & music
	<p>Answer call</p> <p>Press the <b>Multi-function</b> button</p> <p>Alternatively, move the microphone down to answer a call</p>
	<p>End call</p> <p>Press the <b>Multi-function</b> button</p>
	<p>Reject call</p> <p>Double-press the <b>Multi-function</b> button</p>
	<p>Bring Microsoft Teams to foreground on computer</p> <p>Press the <b>Microsoft Teams</b> button* (when signed into Microsoft Teams)</p>
	<p>Join active Microsoft Teams meeting</p> <p>Press the <b>Microsoft Teams</b> button* (when signed into Microsoft Teams)</p>
	<p>View Microsoft Teams missed calls and voicemails</p> <p>Press the <b>Microsoft Teams</b> button* (when signed into Microsoft Teams)</p>

\*Requires Microsoft Teams headset variant

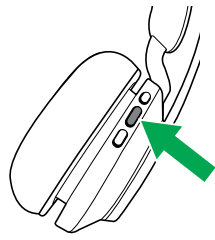

Play/pause music

Press the **Play/Pause** button

Alternatively, the headset will pause music when it is placed on a flat surface, and will resume music when lifted from a flat surface.

Adjust volume

Press the **Volume up** or **Volume down** button, when listening to music or on a call

Next track

Press and hold (1 sec) the **Volume up** button

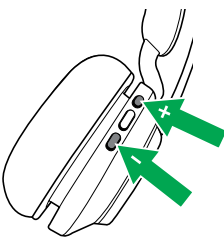

Restart track or previous track

Press and hold (1 sec) the **Volume down** button to restart the current track

Press and hold twice to play the previous track

Busylight on/off

Press the **Volume up** and **Volume down** buttons at the same time

Hear battery status

Press the **Volume up** or **Volume down** buttons when not on a call or listening to music

---

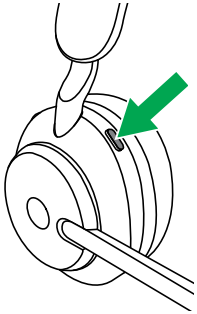
	<p>Activate Voice Assistant (Siri, Google Assistant)</p>	<p>Press the <b>Voice</b> button, when not on a call</p>
	<p>Mute/unmute microphone</p>	<p>Press the <b>Voice</b> button, when on a call</p>
		<p>Alternatively, move the microphone boom-arm up to mute, or down to unmute</p>

---

## 7.3 Busylight(s)

---

The Busylight(s) on the headset automatically light up red when you are on a call to indicate to colleagues that you are busy. To manually switch the Busylight(s) on/off, press the **Volume up** and **Volume down** buttons at the same time.

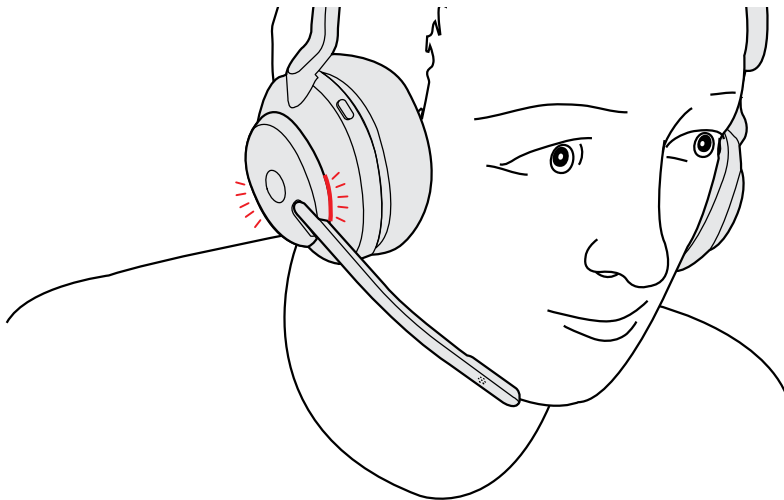

## 7.4 Mute/unmute using the microphone boom-arm

---

The headset microphone can be muted by moving the microphone boom-arm up, or unmuted by moving it down. This feature is on by default, and can be disabled using Jabra Sound+ on your smartphone or Jabra Direct on your computer.

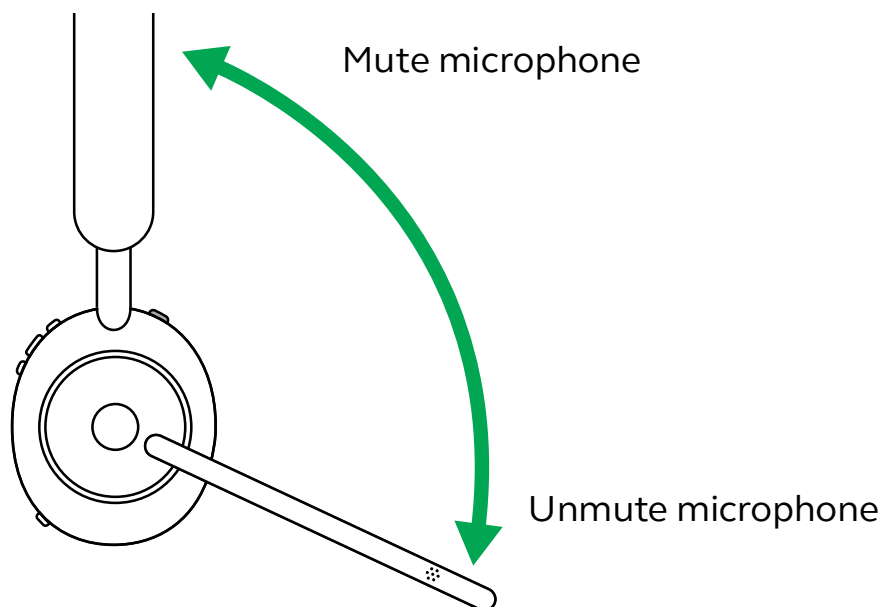

## 7.5 Answer call using the microphone boom-arm

---

An incoming call can be answered by moving the microphone boom-arm down, close to your mouth. This feature is on by default, and can be disabled using Jabra Sound+ on your smartphone or Jabra Direct on your computer.

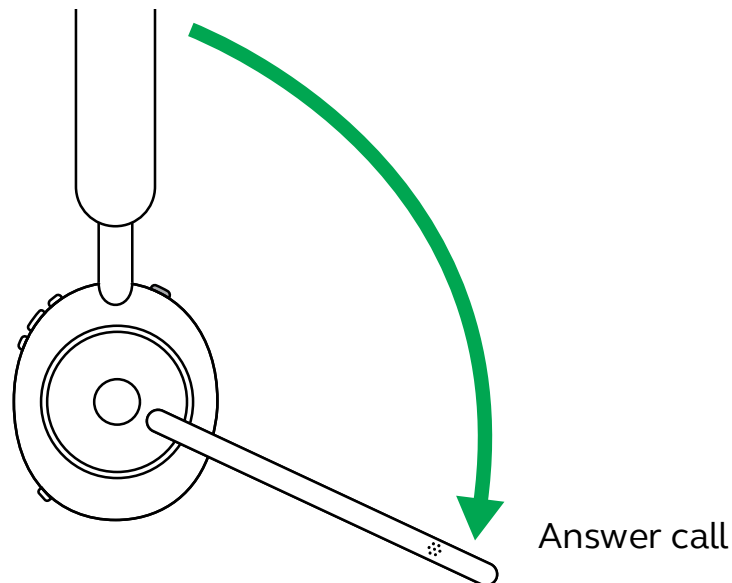

## 7.6 Voice Assistant

---

The Jabra Evolve2 65 enables you to speak to Siri, Google Assistant on your smartphone using the **Voice** button.

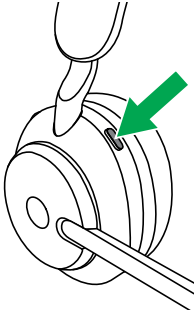
Right	Voice Assistant
	<p>Activate Voice Assistant (Siri, Google Assistant)</p> <p>Press the <b>Voice</b> button, when not on a call</p>

---

## 7.7 Multiuse

---

The headset can be paired to up to 8 Bluetooth devices, and and connected to two Bluetooth devices at once (e.g. the Jabra Link 380 and a smartphone, or two smartphones). The headset can accept multiple incoming calls from either device.

To pair to two smartphones, use the normal pairing process separately for each smartphone (refer to section 6).

Note: Voice assistant will be activated on the last connected smartphone.



## 7.8 Multiple call handling

---

The headset can accept and handle multiple calls at the same time.

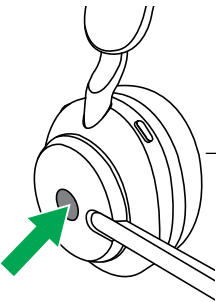
Right	Multiple call handling	
	End current call and answer incoming call	Press the <b>Multi-function</b> button
	Put current call on hold and answer incoming call	Hold (2 secs) the <b>Multi-function</b> button*
	Switch between held call and active call	Hold (2 secs) the <b>Multi-function</b> button*
	Reject incoming call, when on a call	Double-press the <b>Multi-function</b> button

\*Non-Microsoft Teams headset variant only

## 7.9 Voice guidance

---

Voice guidance are announcements that will guide you through set up, or will give you headphone status updates (e.g. connection and battery status).

Voice guidance is enabled by default.

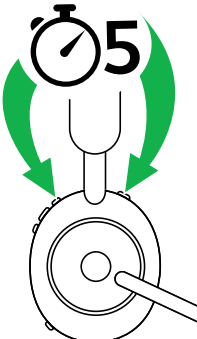
Right	Voice guidance
	<p>Turn Voice guidance on/off</p> <p>Press and hold (5 sec) the <b>Voice</b> button and the <b>Volume up</b> button until you hear an announcement in the headset</p>

Alternatively, use Jabra Direct on your computer, or Jabra Sound+ on your smartphone, to turn Voice guidance on or off.

For the latest list of supported languages, refer to the Jabra Sound+ app on your smartphone or Jabra Direct on your computer.

## 7.10 Sidetone

---

Sidetone enables you to better hear your own voice when you are on a call.

Sidetone settings can be configured using the Jabra Sound+ app on your smartphone or Jabra Direct on your computer.

## 7.11 How to reset

---

Resetting the headset clears the list of paired devices and resets all settings.

Right

Reset headset

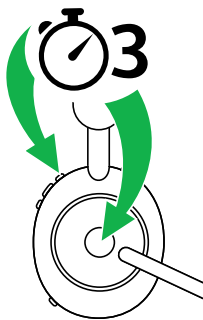

Reset pairing list and settings

Ensure the headset is powered on and you are not on a call. Then press and hold (3 sec) the **Multi-function** button and the **Volume up** button simultaneously until the LED lights up purple and you hear an announcement in the headset

You will need to re-pair the headset to your Jabra Link 380.

# 8. Software and firmware

## 8.1 Jabra Sound+

---



The image shows a smartphone displaying the Jabra Sound+ app interface. The screen displays the following elements: a status bar at the top with 'No SIM', signal strength, time '00:28', and battery level '82%'; the app title 'Jabra Elite 85h'; a 'Preferences' section with a gear icon; 'Surrounding audio mode' with a car icon; 'HearThrough' with a moon icon and a toggle switch; 'Music equalizer' with a circular refresh icon; a graph with a yellow line and white dots; labels 'Bass', 'Mid-range', and 'Treble' below the graph; and 'Soundscape' with a list icon. At the bottom, there are three icons: 'Moments', 'Discover', and 'About'.



**Jabra Sound+ app**

 Personalize your music and calls

 Fine tune your music with MySound

 Download on the App Store

 GET IT ON Google Play

## 8.2 Jabra Direct

---

Jabra Direct is computer software designed to support, manage and enable optimal functionality for Jabra devices.

Download the latest free version from [jabra.com/direct](https://jabra.com/direct)

## 8.3 Update firmware

---

Firmware updates improve performance or add new functionality to Jabra devices.

Firmware can be updated using either Jabra Direct or the Jabra Sound+ app. Both applications will notify you when a firmware update is available.

# 9. Support

## 9.1 FAQ

---

View the FAQs on [Jabra.com/help/evolve2-65](https://www.jabra.com/help/evolve2-65)

## 9.2 How to care for your headset

---

- Always store the headset in the supplied case.
- To prevent the depletion of the battery lifetime or capacity, avoid storing the headset in hot or cold environments, such as a closed car in summer, or in winter conditions.
- It is recommended to keep the headset between -20°C and 55°C (-4°F and 131°F).
- Do not store the headset for extended periods of time without recharging them (max. three months).

